

# TTX Series Bench Table Seating Units



Flexible, Easy to Use... A Perfect Fit.

Built to Last.

Proudly manufactured in the UK.



*TTX13 Series Bench Unit shown:  
307 cm [10 ft] long x 74 cm [29 in] high with Dusty Jade Laminate Tops & Seringa Laminate Benches*

| [www.sicoinc.com](http://www.sicoinc.com) |

## TTX Series Bench Table Seating Unit (TSU) Features



### Tabletops & Benches

#### MDF Core Tabletop:

Made with extremely durable 18mm MDF. Stronger than plywood or particleboard, is lightweight, and resists warping.

#### High-Pressure Laminate:

Tough Formica 0.7 mm thick high-pressure laminate for added durability and long-term wear. 24 standard colours are available to fit any dining area decor.

#### Rigid Vinyl Backer Sheet:

Far superior to all types of paper backers. Applied to the underside of the tabletops for moisture control and easy clean-up (including chewing gum removal), stain resistance and fantastic appearance.

#### SICO® ARMOR-EDGE®:

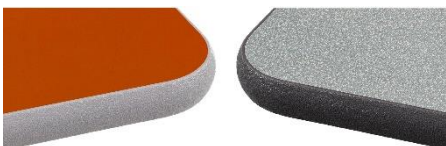

The most durable edge available. Provides an incredibly tough edge to take hard everyday abuse without damage. Hermetically seals the

tabletop for sanitary purposes and prevents moisture from entering.

#### Multiple Heights:

Choose from multiple heights.

#### Tamper Proof Expansion Rivets:

Fastens tabletop firmly to the frame.

#### Centre Gravity Lock Bar:

Ø12 mm centre gravity lock bar prevents anyone from raising centre of table by sitting on the table end. Easily released from either side.

#### Heavy Duty Vertical Hinge Plates with Low Friction Bushing:

Extra heavy self-cleaning hinge plates that will not trap food while providing superb strength, security, and durability.



### Frame

#### 14- & 16-Gauge Steel Tube:

Manufactured from high strength

steel tube. Flexibility is designed into the legs to allow for contained motion and the way students use the tables today.

#### Swivel Castors:

All TTX13-B bench TSU's are fitted with 4 x Ø 10 cm [Ø 4 in] swivel castors fitted with non-marking tyres with a wide surface area for smoother rolling.



The location stem on each castor is solid steel. Plastic thread guards prevent the accumulation of debris, so allowing the wheels to rotate freely.

#### Protective Neoprene Glides:

Non-marking glides protect floors and dampen noise whilst keeping the table in place. These reinforced glides contain metal washers to prevent the leg tubes from breaking through bottom.

#### Aircraft Locknuts:

Tamper-resistant locknuts are used at all mounting points and will not

# FEATURES & BENEFITS

loosen over time.

## Limited Warranty

Protected by a 15-year warranty against manufacturer's defects, and a Lifetime warranty on welds. Visit [www.sicoinc.com](http://www.sicoinc.com) for all warranty details.

### Serial Number:

All TTX series Bench Table Seating Units are identified by a unique Barcode Serial Number attached to the frame for easy identification.

## Transport & Storage

### Self-Storing Mobile Unit:

Designed to be a self-contained mobile unit for efficient single person set up & easy storage, resulting in considerable savings in labour & time. No need for additional transport carts, or heavy lifting.

### Folding for Transport & Storage:

When folding the table seating unit for transportation, a yellow painted lock bar engages between the two tops to provide a stable 'A' shaped structure that can be safely wheeled about.

## Space Design

Take advantage of our FREE space design service to determine the optimal layout and number of products for your space.

# OPTIONS

## Choose Height

Choose from three height options, 26 in, 27 in, or 29 in.

## Choose Frame Finish

Choose from Black or Silver textured epoxy powder coat finishes.

## Choose Tabletop Laminate Finish

Choose from any of the SICO standard range of 24 colours.

## Choose Tabletop Armour Edge Finish

Choose from Black or Grey textured polyurethane armour edging.

## Choose Bench Laminate Finish

Choose from any of the SICO standard range of 24 colours.

## Choose Tabletop Armour Edge Finish

Choose from Black or Grey textured polyurethane armour edging.

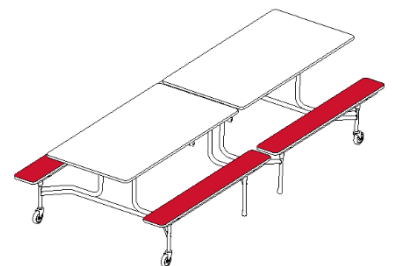
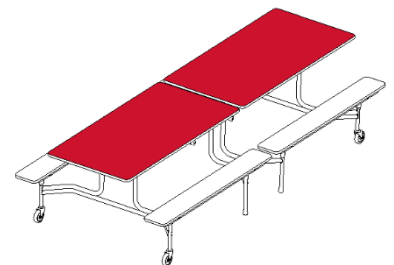
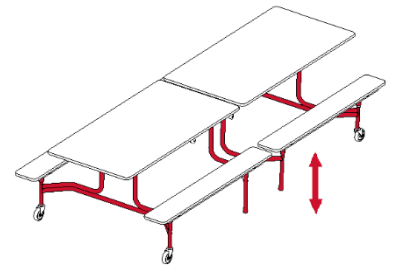

# SPECIFICATIONS

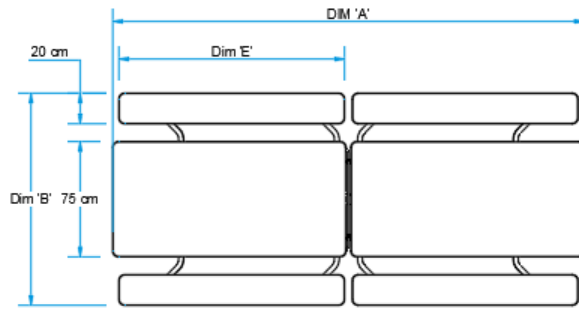

PLAN VIEW

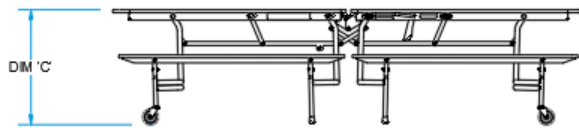

SIDE VIEW

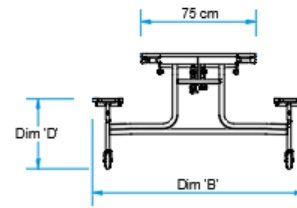

END VIEW

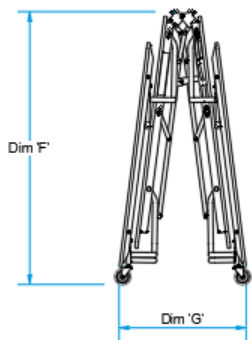

TRANSIT LOCK ENGAGED

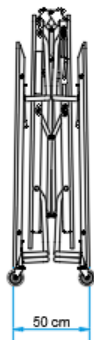

TRANSIT LOCK DISENGAGED FOR STORAGE

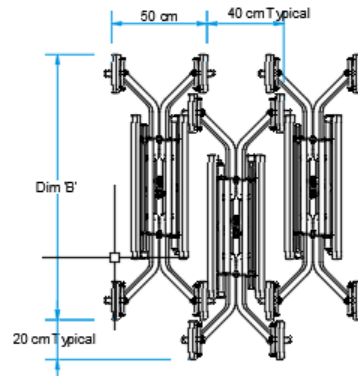

TYPICAL STORAGE DIMENSIONS

## TTX13 Series Bench Table Seating Units

Model	Table Length 'A' cm	O/A Width 'B' cm	Table Height 'C' cm	Bench Height 'D' cm	Bench Length 'E' cm	Transit Lock Height 'F'	Transit Lock Width 'G' cm
TTX13-B-26	307 [10 ft]	138 [54in]	67 [26 in]	38 [14.8 in]	147 [58 in]	178 [70 in]	83 [32.6 in]
TTX13-B-27	307 [10 ft]	138 [54in]	70 [27 in]	40 [15.8 in]	147 [58 in]	180 [71 in]	83 [32.6 in]
TTX13-B-29	307 [10 ft]	138 [54in]	75 [29 in]	45 [17.8 in]	147 [58 in]	185 [73 in]	83 [32.6 in]

*Protect your new products with SICO® service and maintenance*



Whilst all new SICO® products are covered by our warranty, regular servicing as part of a product aftercare package undertaken by our own SICO® Field Service Engineers will reduce excessive wear and tear and extend the product lifespan well beyond the warranty period. In addition to this, having your SICO® products such as Staging, Ramp, and accessories serviced by a SICO® service engineer will ensure compliance with PUWER Regulations requirements.

#### **A SICO® service/health check comprises of:**

- A thorough condition check of all unit components.
- Operational test of the unit.
- Lubrication of all pivot points.
- A safety tolerance check of the unit's torsion bars (if fitted).
- A visual inspection of all welds.
- Adjustment and re-alignment of table legs.
- All missing operating instructions and warning labels replaced.
- Receive a Maintenance report detailing the number, model, age of units.
- Refresher safety training for on-site staff (on request).

Our engineers only fit genuine SICO® parts, including stools, castors, glides, etc.

#### **Repairs outside of warranty, & other SICO® products**

In addition to this, our engineers are also able to undertake servicing and repairs of older existing SICO® products, other SICO® products you may have such as dance floors, room service tables, stage units etc., or repairs which would fall outside of your warranty.

If you wish to discuss any aspect of the above, or arrange a maintenance agreement, a one-off service call, or an engineer call-out and inspection, please do not hesitate to contact our customer service team on:

☎ **01303 234000** ✉ **service@sico-europe.com**

# WANT TO FIND OUT MORE?

Visit [www.sicoinc.com](http://www.sicoinc.com) to see more of our wide variety of innovative products.



**SICO Incorporated** –  
Global Headquarters  
**SICO America Inc.**  
☎ 1 800 328 6138  
✉ [sales@sicoinc.com](mailto:sales@sicoinc.com)

**SICO Japan Inc.**  
☎ +81(3) 3288 0145  
✉ [info@sico-japan.com](mailto:info@sico-japan.com)

**SICO Asia PTE Ltd**  
☎ (65) 6500 0800  
✉ [sales@sicoasia.com](mailto:sales@sicoasia.com)

**SICO Middle East DMCC**  
☎ (971) 4 422 8259  
✉ [sales@sico-me.com](mailto:sales@sico-me.com)

**SICO Europe Ltd**  
☎ +44 (0) 1303 234 000  
✉ [sales@sico-europe.com](mailto:sales@sico-europe.com)

**SICO South Pacific Ltd**  
☎ +61 (2) 4336 1333  
✉ [sales@sicosp.com.au](mailto:sales@sicosp.com.au)